

4

3

2

1

F

F

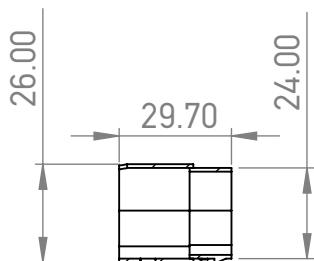

SECTION B-B

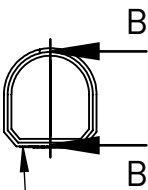
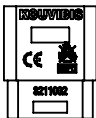

PRT.NR. : 3211003

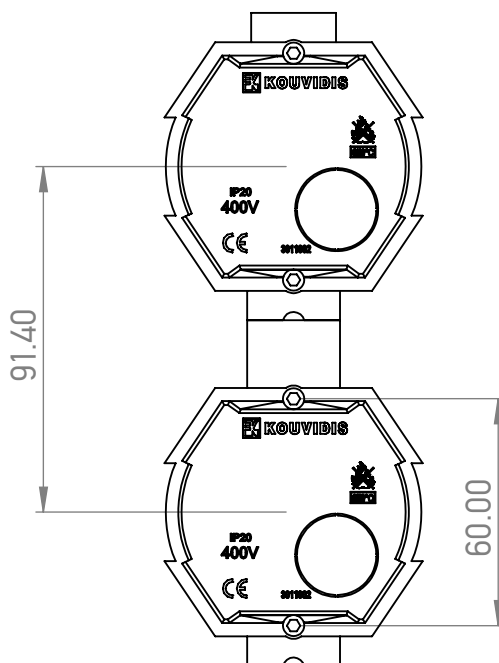

E

E

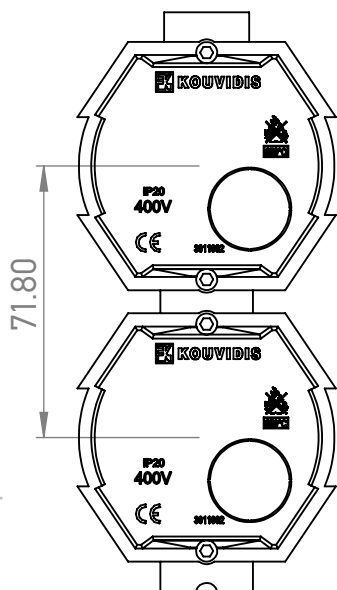

D

D

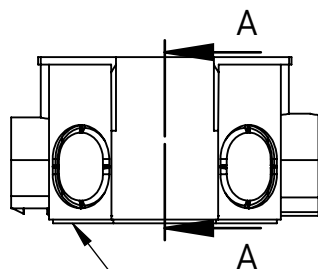

PRT.NR. : 3011003

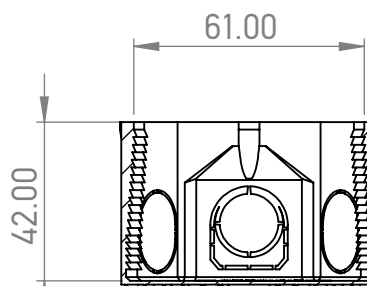

SECTION A-A

C

C

B

B

UNLESS OTHERWISE SPECIFIED,  
DIMENSIONS ARE IN MILLIMETERS

STANDARDS: EN 60670-22

DO NOT SCALE DRAWING

SCALE:1:2

COLOR: YELLOW RAL 1023 BOX, SPACER

PRODUCT NAME

SURFACE FINISH: N/A

MATERIAL: PO blend

TOLERANCES:

RoHS Regulation Applied

LINEAR: 1%

ANGULAR: 1%

PRT.NRS: 3011003, 3211003

COMMENTS:

DWG NO.

SWITCH BOX  
FOR ONE OR MULTI GANG SWITCHES

3011-M-1

A

A

DRAWN

NAME

DATE

The rights of KOUVIDIS intellectual property upon this document are protected by Greek and European law against their use, usurpation, reproduction, trade, alteration, transmission, copy, transfer, distribution, re-publication by third parties and by any means of reason without the express prior written consent or authorization of KOUVIDIS. KOUVIDIS reserves all legal rights against anyone violating its rights as same have been explicitly mentioned above.

1

M.Charkiolakis

01/02/2024

SHEET 1 OF 1

A4

4

3

2

1